

Algebraic combinatorics and trees

F. Chapoton

March 22, 2007

Words and permutations

Let us recall the classical relation between **words** and **associativity**.

An alphabet A is a set of letters $\{a, b, c, \dots\}$. A word w in the alphabet A is a sequence of letters $w = (w_1, w_2, \dots, w_k)$. There is a basic operation on words given by concatenation, which is associative. In fact, the set of words is exactly the free associative monoid on the set A . So the study of words naturally takes place in the setting of associative algebras.

Consider now the alphabet $\{a_1, \dots, a_n\}$. Then the set of words where each letter a_i appears exactly once can be seen as the set of **permutations** of $\{1, \dots, n\}$.

One can find a similar relation between some kinds of trees and some new kinds of algebraic structures.

Correspondence

- words or permutations \longleftrightarrow associative algebras,
- rooted trees \longleftrightarrow pre-Lie algebras,
- planar binary trees \longleftrightarrow dendriform algebras.

The natural setting of this generalisation is the theory of **operads**.

Partitions

Integer partitions are classical in combinatorics and are important too in representation theory.

The Hopf algebra of symmetric functions can be seen as a description of representations of symmetric groups.

The set of planar binary trees should have also such a dual nature.

- partitions \longleftrightarrow modules over the symmetric groups,
- planar binary trees \longleftrightarrow tilting modules on quivers of type A.

There is a natural bijection between planar binary trees and tilting modules over the following quivers:

$$1 \rightarrow 2 \rightarrow 3 \rightarrow \cdots \rightarrow n. \quad (1)$$

Grafting, cutting, pruning, gluing, etc

Algebraic structures on trees did already appear a long time ago, for instance in the work of Butcher in numerical analysis.

Many new algebraic structures on trees have been introduced more recently, notably by Connes and Kreimer. Among them, one can find

- Hopf algebras,
- Lie algebras,
- groups,
- operads.

Operads sometimes provide a way to understand all these objects.

Obviously, trees are used everywhere in combinatorics. For example,

- posets on some sets of trees
- statistics on trees (like permutations)
- bijections or morphisms between trees and permutations
- random trees
- proof of Lagrange inversion using trees
- generating series and the Lambert W function (random graph)

The aim of these lectures is to introduce the notion of operad, in a combinatorial context.

We give definitions of several variants of the notion of operad and illustrate each of them by some specific example.

We also explain how one can build from an operad other algebraic structures, such as a group of "invertible formal power series".

We will concentrate on two particularly nice kinds of trees.

- rooted trees and two related operads
- planar binary trees and two related operads

Four flavours of operads

One has to distinguish four kinds of operads: either we work

- in the category of sets or
- in the category of vector spaces,

and also either with

- symmetric or labeled (with actions of symmetric groups) or
- non-symmetric or unlabeled (without actions of symmetric groups)

objects.

This second dichotomy corresponds also (in some sense) to non-planar or planar trees.

We will consider examples of operads of all four kinds.

- In Set, non-symmetric: Associative, OverUnder
- In Set, symmetric: Commutative, NAP
- In Vect, non-symmetric: Dendriform, Mould
- In Vect, symmetric: pre-Lie

In this section, the notion of operad is introduced, first in the category of sets, then in the category of vector spaces. We give two different definitions and explain how they are related to each other. Operads were first introduced in algebraic topology in the 1960's. More recently, the theory of operads has known further developments in many directions. Operads are useful to describe and work with complicated new kinds of algebras and algebras up to homotopy.

Let us consider the category Set endowed with the Cartesian product \times . In fact, we will consider only finite sets.

There are two flavours of operads in Set , depending on the presence or not of actions of symmetric groups. Let us start with the simplest case, without actions of symmetric groups.

Definition

A non-symmetric operad \mathcal{P} in Set is the data of a set $\mathcal{P}(n)$ for each integer $n \geq 1$, of an element $\mathbf{1}$ in $\mathcal{P}(1)$ and of composition maps

$$\gamma : \mathcal{P}(m) \times \mathcal{P}(n_1) \times \cdots \times \mathcal{P}(n_m) \longrightarrow \mathcal{P}(n_1 + \cdots + n_m) \quad (2)$$

for all integers m, n_1, \dots, n_m .

These data have to satisfy the following conditions.

The element $\mathbf{1}$ is a unit in the following sense:

Unit condition

$$\gamma(\mathbf{1}; p) = p \quad (3)$$

$$\gamma(p; \mathbf{1}, \dots, \mathbf{1}) = p, \quad (4)$$

for all $p \in \mathcal{P}(n)$.

The composition maps γ satisfy the following Associativity:

Associativity condition

$$\begin{aligned} &\gamma(\gamma(p; q_1, \dots, q_n); r_{1,1}, \dots, r_{1,m_1}, r_{2,1}, \dots, r_{2,m_2}, r_{3,1}, \dots, r_{n,m_n}) \\ &= \gamma(p; \gamma(q_1; r_{1,1}, \dots, r_{1,m_1}), \dots, \gamma(q_n; r_{n,1}, \dots, r_{n,m_n})). \end{aligned}$$

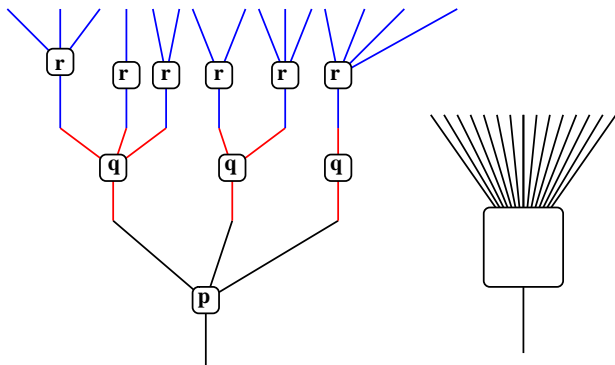

There are two ways to compose, starting with top compositions or starting with bottom composition; they should give the same result.

Planar binary trees

Let us give an example. For this, we need some classical combinatorial objects.

A *planar binary tree* is a finite connected and simply connected graph, having only vertices of valence 1 or 3, embedded in the plane, and with a distinguished vertex of valence 1 called the root. The other vertices of valence 1 are called the leaves. The vertices of valence 3 will from now on simply be called vertices.

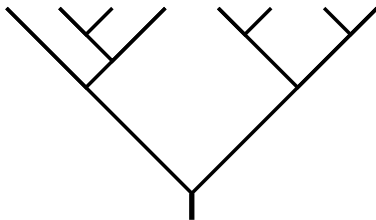

There is standard way to draw such trees: leaves are on a horizontal line on top with a regular spacing and edges are in diagonal directions.

The number of such trees with n vertices is the Catalan number

$$c_n = \frac{1}{n+1} \binom{2n}{n}. \quad (5)$$

Stanley has given 143 different combinatorial interpretations of the Catalan numbers, among which one can cite Dyck paths, planar trees, nonnesting and noncrossing partitions.

Recently, many relations have been found with algebra and representation theory: quasi-symmetric functions, cluster algebras, cluster tilting theory, dual braid monoid, Hopf algebras, etc.

The OverUnder operad

The OverUnder operad OU (also called Duplicial operad) is used by Frabetti in her work on renormalization with planar binary trees. The set $\text{OU}(n)$ is the set of planar binary trees with $n + 1$ leaves.

The unit $\mathbf{1}$ in $\text{OU}(1)$ is the only planar binary tree  with one vertex.

Composition is given by **local substitution** at each inner vertex. Given a planar binary tree T with n vertices, one can number its vertices from left to right from 1 to n . Then given n planar binary trees S_1, \dots, S_n , the composition $\gamma(T; S_1, \dots, S_n)$ is obtained by replacing a neighbourhood of each vertex i of T by the planar binary tree S_i .

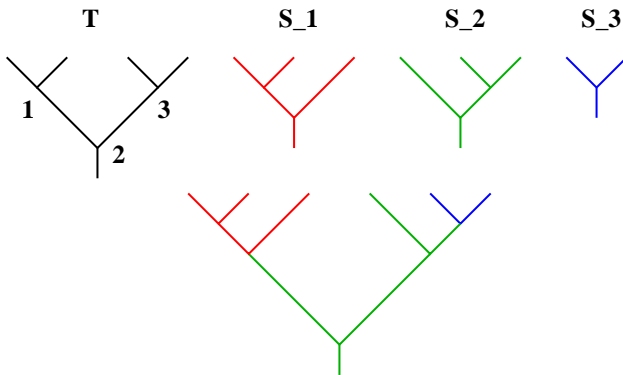

$$\gamma(T; S_1, S_2, S_3) \tag{6}$$

Example of composition in the OU operad.

One has two simple associative operations on planar binary trees: the over ($/$) and under (\backslash) products.

The over product S/T is obtained by grafting the root of S on the leftmost leaf of T .

The under product $S\backslash T$ is obtained by grafting the root of T on the rightmost leaf of S .

In addition to being associative, the over and under product satisfy

$$(x/y)\backslash z = x/(y\backslash z). \quad (7)$$

Alternative axiomatics

There is an alternative presentation of the notion of operad.
Instead of being given by γ maps, the composition is described by maps \circ_i .

- 1 γ maps simultaneous composition
- 2 \circ_i map simple composition

So instead of maps γ as before, we are given a collection of maps \circ_i for all m, n and $1 \leq i \leq m$ from $\mathcal{P}(m) \times \mathcal{P}(n) \rightarrow \mathcal{P}(m+n-1)$.
The \circ_i maps have to satisfy an associativity and a commutativity axiom.

Let x, y, z be in $\mathcal{P}(m), \mathcal{P}(n), \mathcal{P}(p)$ respectively.

- Associativity I (Disjoint composition):
 $(x \circ_i y) \circ_{j+n-1} z = (x \circ_j z) \circ_i y$ for all x, y, z and $i < j$ in $\{1, \dots, m\}$,
- Associativity II (Nested composition):
 $(x \circ_i y) \circ_{j+i-1} z = x \circ_i (y \circ_j z)$ for all x, y, z , i in $\{1, \dots, m\}$
 and j in $\{1, \dots, n\}$,
- Unit: $\mathbf{1} \circ_1 x = x = x \circ_i \mathbf{1}$ for all m , $i = 1, \dots, m$.

The equivalence between the two presentations is obtained by using the unit $\mathbf{1}$.

In one way, the \circ_i maps can be defined directly from the γ maps:

$$x \circ_i y = \gamma(x; \mathbf{1}, \dots, \mathbf{1}, y, \mathbf{1}, \dots, \mathbf{1}), \quad (8)$$

where y is in the i^{th} position.

In the other way, the γ maps can be recovered by iteration of the \circ_i maps:

$$\gamma(p; q_1, \dots, q_n) = (\dots ((p \circ_n q_n) \circ_{n-1} q_{n-1}) \cdots \circ_1 q_1). \quad (9)$$

The operad of endomorphisms of a set

If S is a set, one can define the endomorphism operad of S (denoted by End_S) as the collection $\text{End}_S(n) = \text{Hom}(S^n, S)$ together with the usual composition of maps. The unit $\mathbf{1}$ is the identity in $\text{End}_S(1)$.

If you are given a morphism from another operad P to $\text{End}(S)$, then one says that S has the structure of an **algebra over the operad P** .

For instance, one can show that an algebra over the OU operad is exactly a set endowed with two associative operations $/$ and \backslash satisfying $(x/y)\backslash z = x/(y\backslash z)$.

The Associative operad

The set $\text{Assoc}(n)$ is just a singleton $\{M_n\}$. The unit $\mathbf{1}$ is M_1 . The composition is defined by

$$M_m \circ_i M_n = M_{m+n-1} \quad (10)$$

or by

$$\gamma(M_n; M_{k_1}, \dots, M_{k_n}) = M_{k_1 + \dots + k_n}. \quad (11)$$

This operad has a presentation by generators and relations: it is generated by M_2 and the unique relation is

$$\gamma(M_2; M_2, \mathbf{1}) = \gamma(M_2; \mathbf{1}, M_2). \quad (12)$$

This means that a morphism from Assoc to $\text{End}(S)$ is determined by the image of M_2 , which is a map from $S \times S \rightarrow S$ that has to be associative in the usual sense.

Free operads

Let us define the free operad generated by a collection of sets

$$G = (G_k)_{k \geq 2}.$$

The set $Free_G(n)$ is the set of planar rooted trees with n leaves and with inner vertices of valence $k + 1$ labeled by elements of G_k .

The unit $\mathbf{1}$ is the planar rooted tree without any inner vertex.

Composition is given by **grafting** of a leaf with a root.

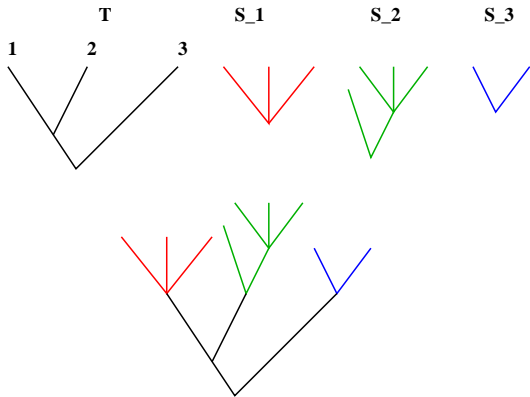

$$\gamma(T; S_1, S_2, S_3) \quad (13)$$

Example of composition in a free operad.

From sets to vector spaces

Many classical operads can not be defined in the category of sets, but only in the category of vector spaces.

The definition is just the same,

- Sets $\mathcal{P}(n) \longleftrightarrow$ Vector spaces $\mathcal{P}(n)$,
- Cartesian product $\times \longleftrightarrow$ tensor product \otimes ,
- maps \longleftrightarrow linear maps.

One can go from an operad in Set to an operad in Vect simply by using the functor “free vector space over a set”.

The combinatorial aspect can survive if there is a nice basis in each vector space $\mathcal{P}(n)$ and a clean description of the composition maps.

The Dendriform operad

The dendriform operad Dend has been introduced by Loday. The initial motivation was from algebraic topology.

The free dendriform algebra on one generator has a basis indexed by planar binary trees.

Later, Loday and Ronco introduced a Hopf algebra on the free dendriform algebra on one generator. This is now called the Hopf algebra of planar binary trees or Loday-Ronco Hopf algebra.

The vector space $\text{Dend}(n)$ has a basis indexed by planar binary trees with n vertices.

The unit $\mathbf{1}$ in $\text{Dend}(1)$ is the tree .

Composition has a combinatorial description using **pairs of shuffles**.

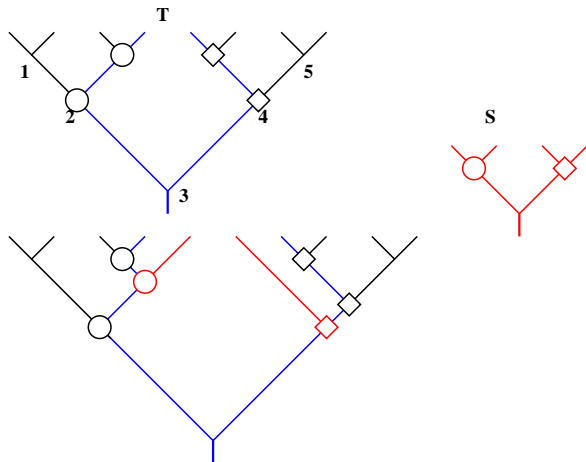

One term in the composition $T \circ_3 S$ in the Dend operad.

More recently, it has been shown that the dendriform operad has a more refined structure: it is an **anticyclic operad**.

This implies in particular that there is a natural action of the cyclic group $\mathbb{Z}/(n+1)\mathbb{Z}$ on the vector space $\text{Dend}(n)$.

Action of the cyclic group of order 4 on $\text{Dend}(2)$ and $\text{Dend}(3)$

$$\begin{bmatrix} -1 & 1 \\ -1 & 0 \end{bmatrix} \begin{bmatrix} -1 & 0 & 1 & 1 & -1 \\ -1 & 0 & 1 & 0 & 0 \\ 0 & -1 & 0 & 1 & 0 \\ -1 & 0 & 0 & 0 & 0 \\ 0 & -1 & 0 & 0 & 0 \end{bmatrix} \quad (14)$$

The basis are $\left\{ \begin{array}{c} \diagdown \\ \diagup \end{array} , \begin{array}{c} \diagup \\ \diagdown \end{array} \right\}$ and $\left\{ \begin{array}{c} \diagdown \\ \diagup \\ \diagdown \end{array} , \begin{array}{c} \diagup \\ \diagdown \\ \diagup \end{array} , \begin{array}{c} \diagdown \\ \diagdown \\ \diagup \end{array} , \begin{array}{c} \diagup \\ \diagup \\ \diagdown \end{array} , \begin{array}{c} \diagdown \\ \diagdown \\ \diagdown \end{array} \right\}$.

This action is NOT given by a permutation of the planar binary trees.

There is a natural map from planar binary trees to rational functions, which goes as follows.

Let us fix an integer n and n indeterminates $\{u_1, \dots, u_n\}$.

Then a planar binary tree T defines a set of intervals in $\{1, \dots, n\}$: to each inner vertex corresponds a pair of leaves and these leaves enclose an interval.

The planar binary tree T is mapped to

$$\frac{1}{\prod_I \sum_{i \in I} u_i}, \quad (15)$$

where the product runs over the set of intervals defined by T .

Example

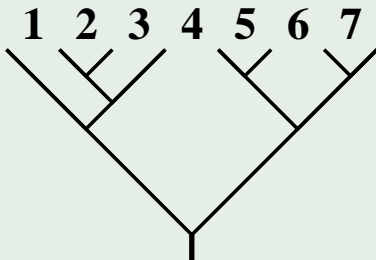

This planar binary tree is mapped to

$$\frac{1}{(u_1 + u_2 + u_3)(u_2)(u_2 + u_3)(u_1 + \cdots + u_7)(u_5)(u_5 + u_6 + u_7)(u_7)}.$$

It is clear that this map is injective from the set of planar binary trees to the set of rational functions: just factorise the fraction to recover the tree.

Less obviously, the associated linear map is also injective.

All this is related to the work of Ecalle and the notion of **mould**.

Theorem

This defines an injective map of the Dendriform operad into an operad M of rational functions, with $M(n) = \mathbb{Q}(u_1, \dots, u_n)$.

On the fractions, there is also an action of the cyclic group $\mathbb{Z}/(n+1)\mathbb{Z}$ given by substitution

$$u_i \mapsto u_{i-1} \text{ and } u_1 \mapsto -(u_1 + \dots + u_n). \quad (16)$$

This is compatible with the injection and gives back the cyclic action on planar binary trees.

Non-crossing trees

One can use this map into fractions to describe a subset of Dend which is closed under composition. Consider a regular polygon with a finite number $n + 1$ of vertices. Assume that there is a distinguished side called the **base**. Recall that a non-crossing tree is a set of diagonals between vertices of this polygon such that

- No two of them intersect
- all vertices are connected by these diagonals
- there are no loops

We will furthermore assume that it contains the base. The number of such trees is

$$\frac{1}{n} \binom{3n-2}{2n-1}. \quad (17)$$

Example

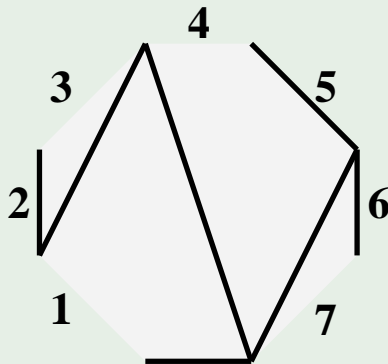

This non-crossing tree is mapped to

$$\frac{1}{(u_2)(u_2 + u_3)(u_1 + \cdots + u_7)(u_5)(u_6)(u_4 + u_5 + u_6 + u_7)(u_6 + u_7)}.$$

There is an operad on non-crossing trees. The unit **1** is the unique tree in the 2-polygon.

Composition is given by **gluing** the base side of one tree along a chosen side of the other one, then removing the base in order to avoid creating a loop.

By mapping non-crossing trees to fractions (this is injective), one gets fractions which are in the image of Dend . Hence non-crossing trees can be seen as a sub-operad of the operad Dend .

Symmetric operads are slightly more complicated than non-symmetric operads. Instead of being given a collection of sets indexed by the integers, the underlying data is a **species**.

Species

The theory of **species** has been introduced by Joyal as a natural categorical setting for generating functions and bijections.

Definition

A species F is a functor from the category of finite sets and bijections to the category of finite sets.

This just means that given a finite set I , there is a natural way to build a set $F(I)$ out of it, without using any specific properties of the elements of I .

This implies that there is a natural action of the bijections of I on $F(I)$.

Moreover F can be uniquely recovered from the collection $F(\{1, \dots, n\})$ and the action of symmetric groups.

For instance, one has the species L of lists: $L(I)$ is the set of total orders on I .

Most of the usual labeled combinatorial objects can be described by species.

For instance, there are species for labelled graphs, for labelled posets, for set partitions, for labelled hypergraphs, and so on.

As a "technology", species have been used a lot by the UQAM team in combinatorics.

One can define operations on species:

| | |
|---|-------------------|
| $(F')(I) = F(I \sqcup \{\bullet\})$ | derivation, |
| $(F \sqcup G)(I) = F(I) \sqcup G(I)$ | disjoint union, |
| $(FG)(I) = \sqcup_{I=J \sqcup K} F(J) \times G(K)$ | product, |
| $(F \cdot G)(I) = F(I) \times G(I)$ | Hadamard product, |
| $(F \circ G)(I) = \sqcup_{\simeq} F(I/\simeq) \times \prod_{J \in I/\simeq} G(J)$ | composition, |

where \simeq runs over the set of equivalence relations on I .

To each species F corresponds an exponential generating series:

$$F(x) = \sum_{n \geq 0} \#F(\{1, \dots, n\}) \frac{x^n}{n!}. \quad (18)$$

Each species F can be associated with a symmetric function

$$Z_F = \sum_{n \geq 0} Z_n(F), \quad (19)$$

where $Z_n(F)$ is the symmetric function associated with the action of the symmetric group \mathfrak{S}_n on the set $F(\{1, \dots, n\})$.

The operations on species correspond to the same operations on generating functions or symmetric functions.

A symmetric operad in the category of sets is a species \mathcal{P} together with a morphism from $\mathcal{P} \circ \mathcal{P}$ to \mathcal{P} which takes the place of the composition map γ and should be associative.

The unit $\mathbf{1}$ is given by a natural system of distinguished elements in the images of singletons by \mathcal{P} .

This is just an instance of the definition of a monoid in a monoidal category.

If one wants to use the analog of the \circ_i products instead of the γ maps, one can give, for all sets I, J and $i \in I$, maps

$$\circ_i : \mathcal{P}(I) \times \mathcal{P}(J) \longrightarrow \mathcal{P}(I \setminus \{i\} \sqcup J) \quad (20)$$

that have to satisfy some naturality properties, which are generally obvious in all examples.

One can give an alternative axiomatics of symmetric operads by using instead of a species S the equivalent data of a collection of sets $S(n) = S(\{1, \dots, n\})$ with actions of the symmetric groups \mathfrak{S}_n .

This becomes heavy, because of **renumbering**. For instance, there is an operad on the species L where $L(I)$ is the set of total orders on I . The composition \circ_i is given by insertion of a total order as a segment at some point of another one:

Using species

$$(b, a, c, f, e, d) \circ_c (u, r, p, s, t, q) = (b, a, u, r, p, s, t, q, f, e, d). \quad (21)$$

Using species

$$(b, a, c, f, e, d) \circ_c (u, r, p, s, t, q) = (b, a, u, r, p, s, t, q, f, e, d). \quad (22)$$

The same statement would become, after choosing the obvious numberings of $\{a, b, c, d, e, f\}$ and $\{p, q, r, s, t, u\}$:

Using actions of symmetric groups

$$(2, 1, 3, 6, 5, 4) \circ_3 (6, 3, 1, 4, 5, 2) = (2, 1, 8, 5, 3, 6, 7, 4, 11, 10, 9). \quad (23)$$

Example: the Commutative operad

The set $\text{Comm}(I)$ is just a singleton $\{I\}$ for all non-empty I .
As a species, this is usually called the species of non-empty sets denoted by E^+ , with generating series $E^+(x) = \exp(x) - 1$.
The unit is the unique element in $\text{Comm}(\{i\})$ for all singletons.
For composition, there is no choice.
Algebras over this operad are just commutative and associative algebras.

Rooted trees

Definition

A rooted tree is a finite connected and simply connected graph with a distinguished vertex, called the root.

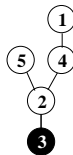

They are very classical combinatorial objects, going back at least to Cayley.

Classical result (Cayley)

There are n^{n-1} distinct rooted trees with vertices $\{1, 2, \dots, n\}$.

The NAP operad

The NAP operad has been introduced by Livernet. The name NAP stands for "non-associative permutative".

The set $\text{NAP}(I)$ is the set of rooted trees on I .

The unit is the unique rooted tree on the set $\{i\}$ for any singleton.

Composition \circ_i of a rooted tree T at the vertex i of a rooted tree S is described as follows.

Consider the forest obtained by removing the vertex i of S . Take the disjoint union with T . Add an edge between the root of T and all vertices of the forest that were connected to i in S .

The root of the result is taken to be the root of S if i is not the root of S and the root of T otherwise.

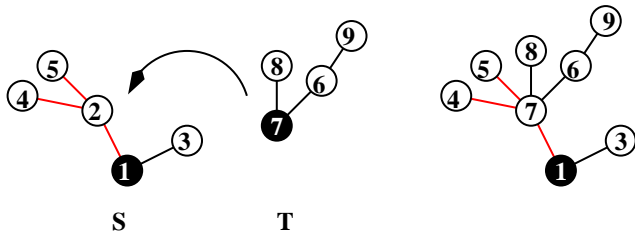

Example of \circ_2 product in NAP from
 $\text{NAP}(\{1, 2, 3, 4, 5\}) \times \text{NAP}(\{6, 7, 8, 9\})$ to
 $\text{NAP}(\{1, 3, 4, 5, 6, 7, 8, 9\})$.

One has to identify the root of T and the vertex i of S . The label

i disappears.

One can play a similar game using vector spaces instead of finite sets.

A **vectorial species** is a functor from the category of finite sets and bijections to the category of vector spaces.

This is also called an \mathfrak{S} -module, as this is equivalent to the data of a collection of modules on all symmetric groups.

Then the same definition as before gives a notion of symmetric operad in the category of vector spaces.

Example: the PreLie operad and pre-Lie algebras

The Pre-Lie operad has been introduced by C-Livernet. But the notion of pre-Lie algebra was known long before. It was used by Gerstenhaber in his study of deformation theory. There is a pre-Lie algebra structure on the Hochschild complex.

It was also used in relation with vector fields on the affine space, or more generally on spaces endowed with a flat and torsion-free connection, i.e. an affine structure. The space of sections of the tangent bundle then has the structure of a pre-Lie algebra.

A pre-Lie algebra is a vector space with a product \curvearrowright satisfying

Pre-Lie axiom

$$(x \curvearrowright y) \curvearrowright z - x \curvearrowright (y \curvearrowright z) = (x \curvearrowright z) \curvearrowright y - x \curvearrowright (z \curvearrowright y). \quad (24)$$

But there are many more examples, more algebraic or combinatorial.

For instance, any operad gives a pre-Lie algebra. In the non-symmetric case, the pre-Lie product on the direct sum $\bigoplus_n \mathcal{P}(n)$ is given for $x \in \mathcal{P}(n)$ and $y \in \mathcal{P}(m)$ by

$$x \curvearrowright y = \sum_{i=1}^n x \circ_i y. \quad (25)$$

Pre-Lie algebras are devices which encode the combinatorics of the “sum of insertion at all possible places”

For instance, one could consider trivalent graphs with three external legs. Then the sum of insertion at all possible vertices defines a pre-Lie product on the vector space spanned by these graphs.

Each pre-Lie algebra gives a Lie algebra, by the formula

$$[x, y] = x \curvearrowright y - y \curvearrowright x. \quad (26)$$

In this way, pre-Lie algebras are some kind of weak associative algebras.

Once we have a Lie algebra, there is a group and a Hopf algebra also.

The commutative Hopf algebra of functions on the group has a nice property: when coordinates are chosen in a nice way, the coproduct is linear on one side.

On a more geometric side, this is related to the notion of “group with a left-invariant affine structure”

The PreLie operad

The set $\text{PreLie}(I)$ is the set of rooted trees on I .

The unit is the unique rooted tree on the set $\{i\}$ for any singleton.

In a rooted tree, one can orient the edges towards the root.

Composition \circ_i of a rooted tree T at the vertex i of a rooted tree S is described as a sum over the set of functions from incoming edges at vertex i in S to vertices of T . Pick such a function ϕ .

Consider the forest obtained by removing the vertex i of S . Take the disjoint union with T .

Add an edge between each vertex of the forest that were connected to i in S and the corresponding vertex of T given by ϕ . If the vertex i had an outgoing edge in S , connect the other vertex of this edge to the root of T .

The root of the result is taken to be the root of S if i is not the root of S and the root of T otherwise.

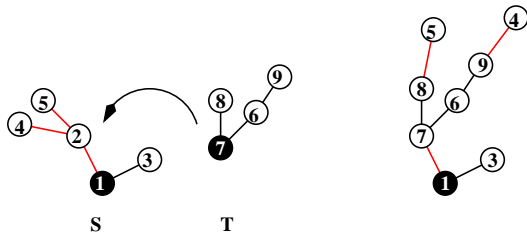

Example: one term in a \circ_2 product in PreLie from $\text{PreLie}(\{1, 2, 3, 4, 5\}) \times \text{PreLie}(\{6, 7, 8, 9\})$ to $\text{PreLie}(\{1, 3, 4, 5, 6, 7, 8, 9\})$.

The pre-Lie operad has more structure: it is an anticyclic operad. This means that there is natural action of the cyclic group \mathfrak{S}_{n+1} on the space $\text{PreLie}(\{1, \dots, n\})$ extending the action of \mathfrak{S}_n . There is a similar "cyclic" structure on the operad Assoc , which is much easier to explain. Recall that the operad Assoc (as a symmetric operad) is based on the species of lists: $\text{Assoc}(I)$ is the set of total orders on I . One can extend uniquely a total order on I to a cyclic order on $I \sqcup \{\bullet\}$. Then there is an action of the bigger symmetric group of $I \sqcup \{\bullet\}$ on the set $\text{Assoc}(I)$.

Returning to the pre-Lie case, the action of the bigger symmetric group is not easy to describe. One way is to use the usual injective map from the pre-Lie operad into the Dendriform operad to restrict the cyclic action of the Dend operad.

One can for instance show that the iterated bracket (seen inside the PreLie operad)

$$[[\dots [[n, n - 1], n - 2], \dots, 2], 1] \quad (27)$$

is (up to sign) in the same orbit as the iterated pre-Lie product

$$((\dots ((1 \curvearrowright 2) \curvearrowright 3) \dots n - 1) \curvearrowright n). \quad (28)$$

So far, this action is only computable using the operad formalism.

There is a group associated with each operad, some kind of generalized formal power series.

The definition is simpler for non-symmetric operads.

Let \mathcal{P} be a non-symmetric operad in the category of vector spaces.

Let

$$\widehat{\mathcal{P}} = \prod_{n \geq 1} \mathcal{P}(n). \quad (29)$$

On this space (seen as a set), there is an associative product $x \circ y$ which is linear in its left argument. If x is homogeneous of degree n and $y = \sum_{k \geq 1} y_k$, then

$$x \circ y = \sum_{k_1, \dots, k_n} \gamma(x; y_{k_1}, \dots, y_{k_n}). \quad (30)$$

The \circ product is associative and non-linear on its right argument.

One can consider the group of invertible elements in this monoid. The affine subspace of elements $x = \mathbf{1} + \sum_{k \geq 2} x_k$ is a subgroup. For an operad P , this will be called the P -group.

This construction is functorial: a morphism of operads from P to Q gives a morphism of groups from the P -group to the Q -group. There is a distributivity property between operations in the free P -algebra and product on the right with an element G of the P group:

$$(m(A, B, \dots))G = m(AG, BG, \dots) \quad (31)$$

where m is any operation in the free P -algebra induced by the operad P .

For instance, in the case of the Associative operad, the associated group is just the group of series f in one variable t of the shape

$$f = t + \sum_{n \geq 2} f_n t^n \quad (32)$$

for the group law given by **composition** of such series.

In the case of a symmetric operad, the construction is mostly the same.

Let \mathcal{P} be a symmetric operad in the category of vector spaces. Let

$$\widehat{\mathcal{P}} = \prod_{n \geq 1} \mathcal{P}(\{1, \dots, n\})_{\mathfrak{S}_n}, \quad (33)$$

the product of the coinvariants for the action of the symmetric group. This is the completion of the free \mathcal{P} -algebra on one generator with respect to the filtration by n .

There is an associative product \circ on this space, defined by choosing representatives and using the γ maps of the operad just as before. The affine subspace of series where the unit $\mathbf{1}$ has coefficient 1 is a group.

Proof

The series A is easily seen to be the unique solution to

$$A = \text{Y} + A/\text{Y} + \text{Y}\backslash A + A/\text{Y}\backslash A. \quad (34)$$

This amounts to say that a planar binary tree has either zero, one (left or right) or two subtrees.

Multiplying on the right by A^{-1} is compatible with the over and under products. Hence one gets the following equation.

$$A^{-1} = \text{Y} - \text{Y}/A^{-1} - A^{-1}\backslash\text{Y} - \text{Y}/A^{-1}\backslash\text{Y}. \quad (35)$$

One can check that B satisfies this equation. The result follows by uniqueness.

This can be generalized with one parameter a counting the number of right-oriented leaves, with the same proof.

Narayana statistic on all trees

$$A_a = \begin{array}{c} \diagup \diagdown \\ \text{Y} \end{array} + a \begin{array}{c} \diagup \diagdown \\ \diagdown \diagup \\ \text{Y} \end{array} + \begin{array}{c} \diagup \diagdown \\ \diagdown \diagup \\ \diagdown \diagup \\ \text{Y} \end{array} + a^2 \begin{array}{c} \diagup \diagdown \\ \diagdown \diagup \\ \diagdown \diagup \\ \diagdown \diagup \\ \text{Y} \end{array} + a \begin{array}{c} \diagup \diagdown \\ \diagdown \diagup \\ \diagdown \diagup \\ \text{Y} \end{array} + a \begin{array}{c} \diagup \diagdown \\ \diagdown \diagup \\ \text{Y} \end{array} + a \begin{array}{c} \diagup \diagdown \\ \diagdown \diagup \\ \diagdown \diagup \\ \text{Y} \end{array} + \begin{array}{c} \diagup \diagdown \\ \diagdown \diagup \\ \diagdown \diagup \\ \diagdown \diagup \\ \text{Y} \end{array} + \dots$$

Restricted statistic on V-shaped trees

$$B_a = \begin{array}{c} \diagup \diagdown \\ \text{Y} \end{array} - a \begin{array}{c} \diagup \diagdown \\ \diagdown \diagup \\ \text{Y} \end{array} - \begin{array}{c} \diagup \diagdown \\ \diagdown \diagup \\ \diagdown \diagup \\ \text{Y} \end{array} + a^2 \begin{array}{c} \diagup \diagdown \\ \diagdown \diagup \\ \diagdown \diagup \\ \diagdown \diagup \\ \text{Y} \end{array} + a \begin{array}{c} \diagup \diagdown \\ \diagdown \diagup \\ \text{Y} \end{array} + \begin{array}{c} \diagup \diagdown \\ \diagdown \diagup \\ \diagdown \diagup \\ \text{Y} \end{array} + \dots$$

Theorem

In the OverUnder group, $A_a = B_a^{-1}$.

Left combs

$$C = \begin{array}{c} \diagup \\ \diagdown \end{array} + \begin{array}{c} \diagup \\ \diagdown \\ \diagup \\ \diagdown \end{array} + \begin{array}{c} \diagup \\ \diagdown \\ \diagup \\ \diagdown \\ \diagup \\ \diagdown \end{array} + \dots$$

Right combs

$$D = \begin{array}{c} \diagdown \\ \diagup \end{array} + \begin{array}{c} \diagdown \\ \diagup \\ \diagdown \\ \diagup \end{array} + \begin{array}{c} \diagdown \\ \diagup \\ \diagdown \\ \diagup \\ \diagdown \\ \diagup \end{array} + \dots$$

In the OverUnder group, C^{-1} is the alternating version of C .
 One has

$$C + C \setminus D = D + C / D. \quad (36)$$

This just means that a V-shaped tree can be decomposed using right combs and left combs in two different ways.

The **Tamari lattice** is a well-known partial order on the set of planar binary trees with n vertices. The minimal element is the left comb, the maximal element is the right comb. The covering relations are given by local moves of the shape $\begin{array}{c} \diagup \\ \diagdown \end{array} \leq \begin{array}{c} \diagdown \\ \diagup \end{array}$. Let us consider the generating function for the Möbius numbers $\mu(\hat{0}, T)$ in this lattice.

Möbius function in Tamari posets

$$E = \begin{array}{c} \diagup \\ \diagdown \end{array} + \begin{array}{c} \diagdown \\ \diagup \end{array} - \begin{array}{c} \diagup \\ \diagdown \\ \diagup \end{array} + \begin{array}{c} \diagdown \\ \diagup \\ \diagdown \end{array} - \begin{array}{c} \diagdown \\ \diagup \\ \diagup \end{array} - \begin{array}{c} \diagup \\ \diagdown \\ \diagdown \end{array} + \begin{array}{c} \diagdown \\ \diagup \\ \diagdown \\ \diagup \end{array} + \dots$$

Theorem

In the OverUnder group, $E = CD^{-1}$.

As there is a map from the OverUnder operad to the Associative operad (and 2 maps in the other way), one gets a map from the OverUnder group to the group of formal power series in one variable.

This application maps a sum of trees F to the series $\sum_{n \geq 1} f_n t^n$, where f_n is the sum of coefficients of all trees of degree n in F . In the other direction, one can map a formal power series in one variables to a sum of trees by using only left combs or right combs.

$$f = \sum_{n \geq 1} f_n t^n \mapsto F = f_1 \begin{array}{c} \diagup \\ \diagdown \end{array} + f_2 \begin{array}{c} \diagup \\ \diagdown \\ \diagdown \end{array} + f_3 \begin{array}{c} \diagup \\ \diagdown \\ \diagdown \\ \diagdown \end{array} + \dots \quad (37)$$

Series of planar binary trees: the Dendriform group

Consider again the series

Sum of all trees

$$A = \begin{array}{c} \diagup \diagdown \\ \text{Y} \end{array} + \begin{array}{c} \diagup \diagdown \\ \diagup \diagdown \\ \text{Y} \end{array} + \begin{array}{c} \diagup \diagdown \\ \diagup \diagdown \\ \diagup \diagdown \\ \text{Y} \end{array} + \begin{array}{c} \diagup \diagdown \\ \diagup \diagdown \\ \diagup \diagdown \\ \diagup \diagdown \\ \text{Y} \end{array} + \begin{array}{c} \diagup \diagdown \\ \diagup \diagdown \\ \diagup \diagdown \\ \diagup \diagdown \\ \diagup \diagdown \\ \text{Y} \end{array} + \begin{array}{c} \diagup \diagdown \\ \diagup \diagdown \\ \diagup \diagdown \\ \diagup \diagdown \\ \diagup \diagdown \\ \diagup \diagdown \\ \text{Y} \end{array} + \begin{array}{c} \diagup \diagdown \\ \diagup \diagdown \\ \diagup \diagdown \\ \diagup \diagdown \\ \diagup \diagdown \\ \diagup \diagdown \\ \diagup \diagdown \\ \text{Y} \end{array} + \begin{array}{c} \diagup \diagdown \\ \diagup \diagdown \\ \diagup \diagdown \\ \diagup \diagdown \\ \diagup \diagdown \\ \diagup \diagdown \\ \diagup \diagdown \\ \diagup \diagdown \\ \text{Y} \end{array} + \dots$$

In the Dendriform group, A^{-1} is the alternating version of A .
 The OverUnder group and the Dendriform group share the same underlying set, but they are quite different !

Let us consider the generating series for the numbers $\#\{S \mid S \geq T\}$ in the Tamari lattices.

Intervals in Tamari posets

$$\Phi = \begin{array}{c} \diagup \diagdown \\ \text{Y} \end{array} + 2 \begin{array}{c} \diagup \diagdown \\ \diagup \diagdown \\ \text{Y} \end{array} + \begin{array}{c} \diagup \diagdown \\ \diagup \diagdown \\ \diagup \diagdown \\ \text{Y} \end{array} + 5 \begin{array}{c} \diagup \diagdown \\ \diagup \diagdown \\ \diagup \diagdown \\ \diagup \diagdown \\ \text{Y} \end{array} + 3 \begin{array}{c} \diagup \diagdown \\ \diagup \diagdown \\ \diagup \diagdown \\ \diagup \diagdown \\ \diagup \diagdown \\ \text{Y} \end{array} + 2 \begin{array}{c} \diagup \diagdown \\ \diagup \diagdown \\ \diagup \diagdown \\ \diagup \diagdown \\ \diagup \diagdown \\ \diagup \diagdown \\ \text{Y} \end{array} + 2 \begin{array}{c} \diagup \diagdown \\ \diagup \diagdown \\ \diagup \diagdown \\ \diagup \diagdown \\ \diagup \diagdown \\ \diagup \diagdown \\ \diagup \diagdown \\ \text{Y} \end{array} + \begin{array}{c} \diagup \diagdown \\ \diagup \diagdown \\ \diagup \diagdown \\ \diagup \diagdown \\ \diagup \diagdown \\ \diagup \diagdown \\ \diagup \diagdown \\ \diagup \diagdown \\ \text{Y} \end{array} + \dots$$

This can also be seen as a generating series for intervals.
 There is a similar series for intervals satisfying some condition.

Indecomposable intervals

$$\Theta = \begin{array}{c} \diagup \diagdown \\ \text{Y} \end{array} + \begin{array}{c} \diagup \diagdown \\ \diagup \diagdown \\ \text{Y} \end{array} + \begin{array}{c} \diagup \diagdown \\ \diagup \diagdown \\ \diagup \diagdown \\ \text{Y} \end{array} + 2 \begin{array}{c} \diagup \diagdown \\ \diagup \diagdown \\ \diagup \diagdown \\ \diagup \diagdown \\ \text{Y} \end{array} + 2 \begin{array}{c} \diagup \diagdown \\ \diagup \diagdown \\ \diagup \diagdown \\ \diagup \diagdown \\ \diagup \diagdown \\ \text{Y} \end{array} + \begin{array}{c} \diagup \diagdown \\ \diagup \diagdown \\ \diagup \diagdown \\ \diagup \diagdown \\ \diagup \diagdown \\ \text{Y} \end{array} + 2 \begin{array}{c} \diagup \diagdown \\ \diagup \diagdown \\ \diagup \diagdown \\ \diagup \diagdown \\ \diagup \diagdown \\ \diagup \diagdown \\ \text{Y} \end{array} + \begin{array}{c} \diagup \diagdown \\ \diagup \diagdown \\ \diagup \diagdown \\ \diagup \diagdown \\ \diagup \diagdown \\ \diagup \diagdown \\ \text{Y} \end{array} + \dots$$

Theorem

In the Dendriform group, these series satisfy

$$\Theta = \text{Y} + \text{Y} * \Phi \quad \text{and} \quad \Phi = \Theta + \Phi/\Theta. \quad (38)$$

These equations are proved in a combinatorial way.

There are nice one-parameter ("quantum") generalisations of these series, satisfying

$$\Theta = \text{Y} + \text{Y} * \Phi \quad \text{and} \quad \Phi = \Theta + q\Phi/\Theta. \quad (39)$$

As there is a map from the Associative operad to the Dendriform operad, one gets a map from the group of formal power series in one variable to the Dendriform group.

This application maps a series $\sum_{n \geq 1} f_n t^n$ to the sum of trees where all trees of degree n have the same coefficient f_n .

$$f = \sum_{n \geq 1} f_n t^n \mapsto F = f_1 \begin{array}{c} \diagup \\ \diagdown \end{array} + f_2 \left(\begin{array}{c} \diagup \\ \diagdown \diagdown \end{array} + \begin{array}{c} \diagdown \\ \diagup \diagup \end{array} \right) + f_3 \left(\begin{array}{c} \diagup \\ \diagdown \diagdown \diagdown \end{array} + \begin{array}{c} \diagdown \\ \diagup \diagup \diagup \end{array} + \begin{array}{c} \diagup \\ \diagdown \diagup \end{array} + \begin{array}{c} \diagdown \\ \diagup \diagdown \end{array} + \dots \right) \quad (40)$$

Hence, these series form a sub-group of the Dendriform group.

Series of rooted trees: the NAP group

Sum of corollas

$$C = \bullet + \circ + \circ + \circ + \circ + \dots \quad (41)$$

Alternating sum of linear trees

$$L = \bullet - \circ + \circ - \circ + \circ - \dots \quad (42)$$

Theorem

In the NAP group, $C = L^{-1}$.

The proof uses a functional equation.

Consider the series where each rooted tree has weight the inverse of the order of its automorphism group.

Inverse of the automorphism

$$A = \bullet + \begin{array}{c} \circ \\ | \\ \bullet \end{array} + \frac{1}{2} \begin{array}{c} \circ \quad \circ \\ \diagdown \quad / \\ \bullet \end{array} + \begin{array}{c} \circ \\ | \\ \bullet \end{array} + \frac{1}{6} \begin{array}{c} \circ \quad \circ \quad \circ \\ \diagdown \quad | \quad / \\ \bullet \end{array} + \frac{1}{2} \begin{array}{c} \circ \quad \circ \\ | \quad | \\ \bullet \end{array} + \begin{array}{c} \circ \quad \circ \\ | \quad | \\ \bullet \end{array} + \begin{array}{c} \circ \\ | \\ \bullet \end{array} + \dots \quad (43)$$

The inverse of A in the NAP group is the similar sum restricted on corollas and alternating:

Alternating sum of corollas

$$C = \bullet - \begin{array}{c} \circ \\ | \\ \bullet \end{array} + \frac{1}{2} \begin{array}{c} \circ \quad \circ \\ \diagdown \quad / \\ \bullet \end{array} - \frac{1}{6} \begin{array}{c} \circ \quad \circ \quad \circ \\ \diagdown \quad | \quad / \\ \bullet \end{array} + \frac{1}{24} \begin{array}{c} \circ \quad \circ \quad \circ \quad \circ \\ \diagdown \quad | \quad / \quad | \\ \bullet \end{array} + \dots \quad (44)$$

There are two morphisms from the NAP group to the **multiplicative** group of formal power series : either projects on corollas or on linear trees.

There is a morphism from the NAP group to the group of formal power series for **composition** given by the sum of the coefficients of all trees of same degree.

This comes from a morphism from NAP to the Associative operad.

Series of rooted trees: the PreLie group

The PreLie group has the same underlying set as the NAP group, but they are distinct.

Consider again the series where each rooted tree has weight the inverse of the order of its automorphism group.

Inverse of the automorphism

$$A = \bullet + \begin{array}{c} \circ \\ | \\ \bullet \end{array} + \frac{1}{2} \begin{array}{c} \circ \quad \circ \\ | \quad | \\ \bullet \end{array} + \begin{array}{c} \circ \\ | \\ \bullet \\ | \\ \circ \end{array} + \frac{1}{6} \begin{array}{c} \circ \quad \circ \quad \circ \\ | \quad | \quad | \\ \bullet \end{array} + \frac{1}{2} \begin{array}{c} \circ \quad \circ \\ | \quad | \\ \bullet \\ | \\ \circ \end{array} + \begin{array}{c} \circ \quad \circ \\ | \quad | \\ \bullet \\ | \\ \circ \end{array} + \begin{array}{c} \circ \\ | \\ \bullet \\ | \\ \circ \end{array} + \dots \quad (45)$$

Then the inverse of A in the PreLie group is the alternating version of A.

Consider the following series

$$\Delta(s, t) = \bullet + (s+t) \circlearrowleft + (s^2+st) \circlearrowleft \circlearrowleft + (s^2+2st+t^2) \circlearrowleft \circlearrowleft \circlearrowleft + \dots, \quad (46)$$

which is defined by the equation

$$\Delta = \bullet + s \Delta \circlearrowleft \bullet + t \bullet \circlearrowleft \Delta.$$

From this, it follows that the inverse of $\Delta(s, t)$ in the PreLie group is the alternating version of $\Delta(t, s)$.

One can show that Δ is related to the statistic "number of cycles" in permutations.

There is a morphism from the PreLie group to the **multiplicative** group of formal power series, given by projection on corollas.

There is a morphism from the PreLie group to the group of formal power series for **composition**, given by projection on linear trees.

The sum of the coefficients of all trees of same degree defines a morphism from the PreLie group to a group of formal power series related to the Witt Lie algebra.

There is a morphism from the PreLie group to the Dend group, coming from the morphism from PreLie to Dend.

Recall that at some point there was an operad M containing Dend with $M(n) = \mathbb{Q}(u_1, \dots, u_n)$.

There is also an associated group, containing the Dend group and PreLie-groups as subgroups. Its elements are formal sums of rational functions in different numbers of arguments. This is what is called a mould by Ecalle, though he is using a different group structure.

Conclusion

- There are many more nice operads and morphisms between them.
- There are many other interesting series in the associated groups.
- These series over trees can be seen as refined generating series. They can be useful in enumerative problems.
- Some of these groups are implemented in the computer algebra system MuPAD.